

New Haden Pumps

Rainwater Harvesting enviro-PAC



Why use drinking water to flush toilets?

Nature delivers an abundant supply of soft rainwater, directly to buildings. Our system collects this rainwater, filters, stores and provides this on demand for uses such as WC flushing, irrigation, car washing etc.

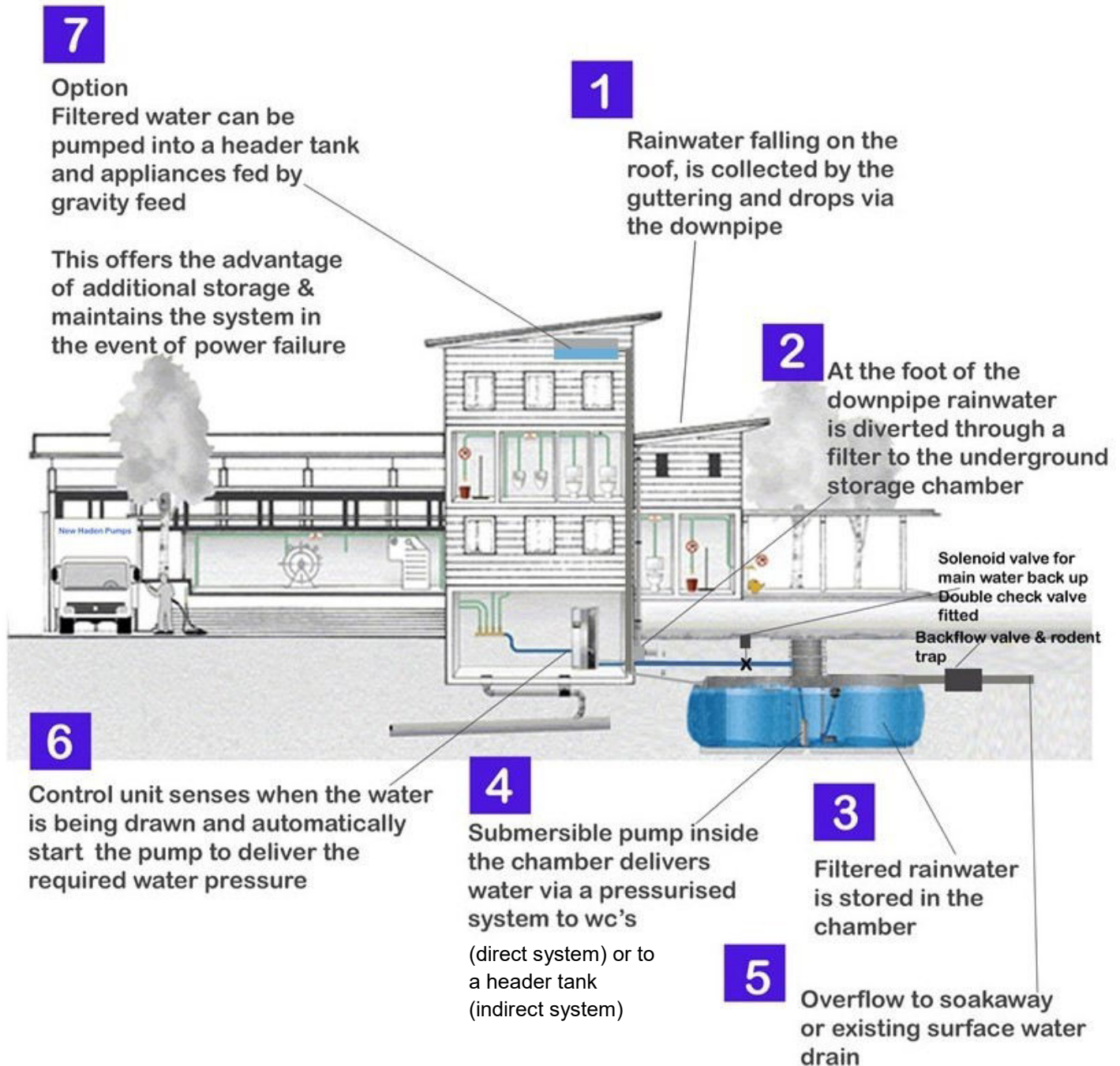

Registered Office:

New Haden Pumps Ltd,
Draycott Cross Road, Cheadle, Staffs, ST10 2NW
Registered in England, No. 826997
VAT No. 849 7500 90

Tel: 01538 757900
Fax: 01538 757999
E-mail: info@NHPumps.com

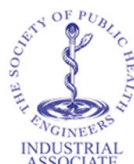

Southern Office:

New Haden Pumps Ltd,
Unit 57, Waterhouse Business Centre,
2, Cromar Way, Chelmsford, Essex,
CM1 2QE

Tel: 01245 392147
E-mail: southern@nhpumps.com

New Haden Pumps

Enviro-PAC Main Components



Tanks

GRP underground storage chamber available in various capacities for domestic and commercial applications.

Shapes and sizes available to suit site requirements.

Above ground chambers also available.

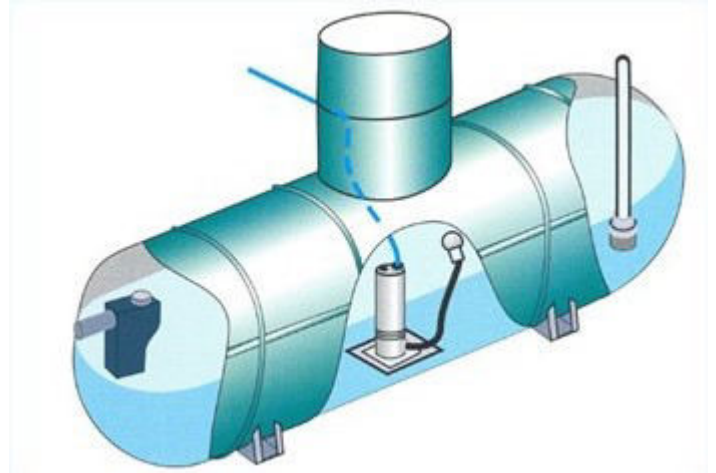

Filters

Underground filter units divert rainwater in to the storage chamber.

Excess water and filtered particles continue into the surface water drain.

Above ground filter unit also available.

Pumps

Submersible pumps are installed inside the storage chamber and incorporate a floating filter.

Surface mounted pumps usually installed inside an adjacent building.

Mains top-up unit operates automatically when there is insufficient rainfall.



UV Water Sterilisation available as an optional extra

This is safe reliable and simple to maintain

Registered Office:

New Haden Pumps Ltd,
Draycott Cross Road, Cheadle, Staffs, ST10 2NW
Registered in England, No. 826997
VAT No. 849 7500 90

Tel: 01538 757900
Fax: 01538 757999
E-mail: info@NHPumps.com



Southern Office:

New Haden Pumps Ltd,
Unit 57, Waterhouse Business Centre,
2, Cromar Way, Chelmsford, Essex,
CM1 2QE

Tel: 01245 392147
E-mail: southern@nhpumps.com

New Haden Pumps

Rainwater Harvesting

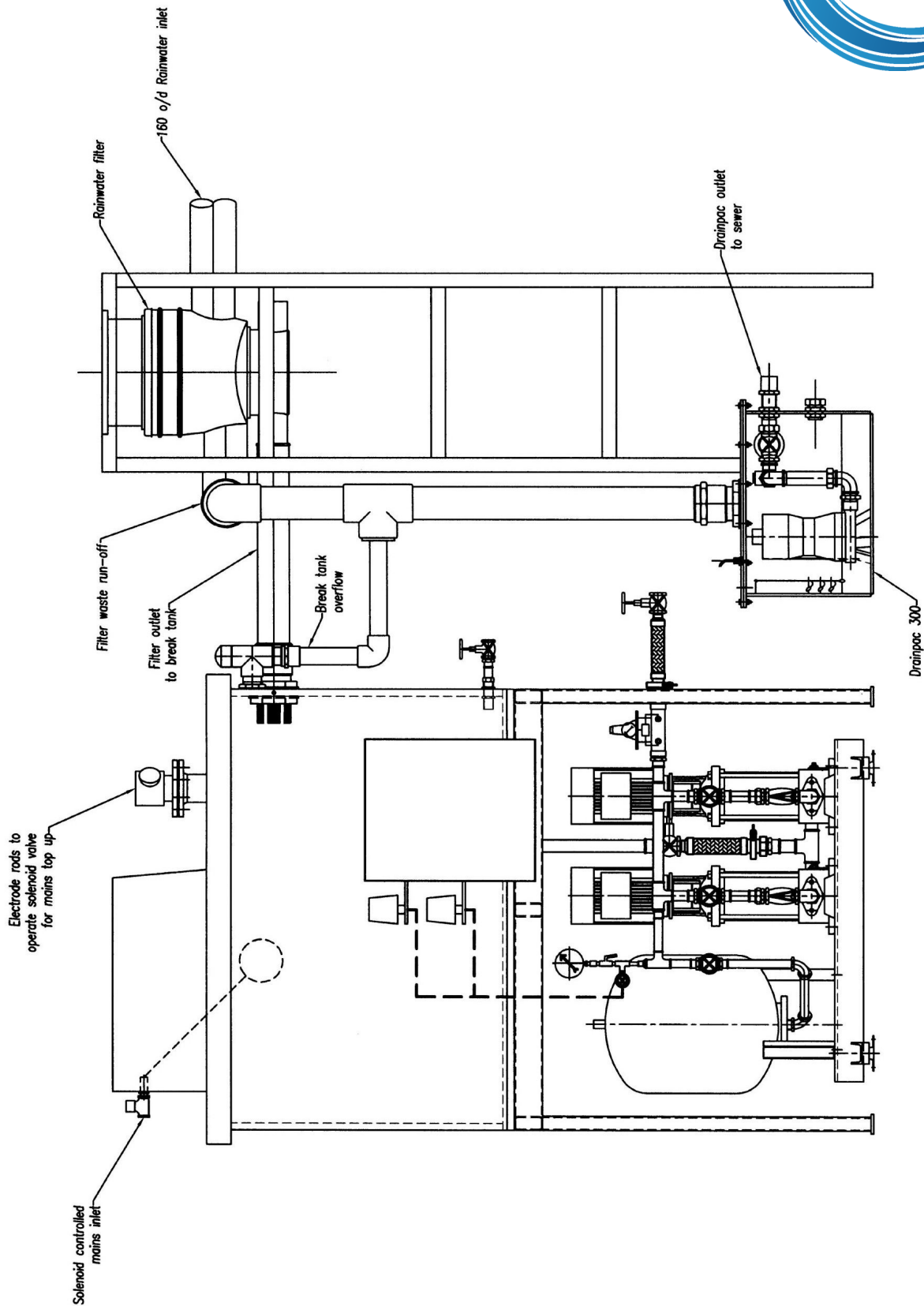

Registered Office:

New Haden Pumps Ltd,
 Draycott Cross Road, Cheadle, Staffs, ST10 2NW
 Registered in England, No. 826997
 VAT No. 849 7500 90

Tel: 01538 757900
 Fax: 01538 757999
 E-mail: info@NHPumps.com



Southern Office:

New Haden Pumps Ltd,
 Unit 57, Waterhouse Business Centre,
 2, Cromar Way, Chelmsford, Essex,
 CM1 2QE

Tel: 01245 392147
 E-mail: southern@nhpumps.com

New Haden Pumps

Rainwater Harvesting

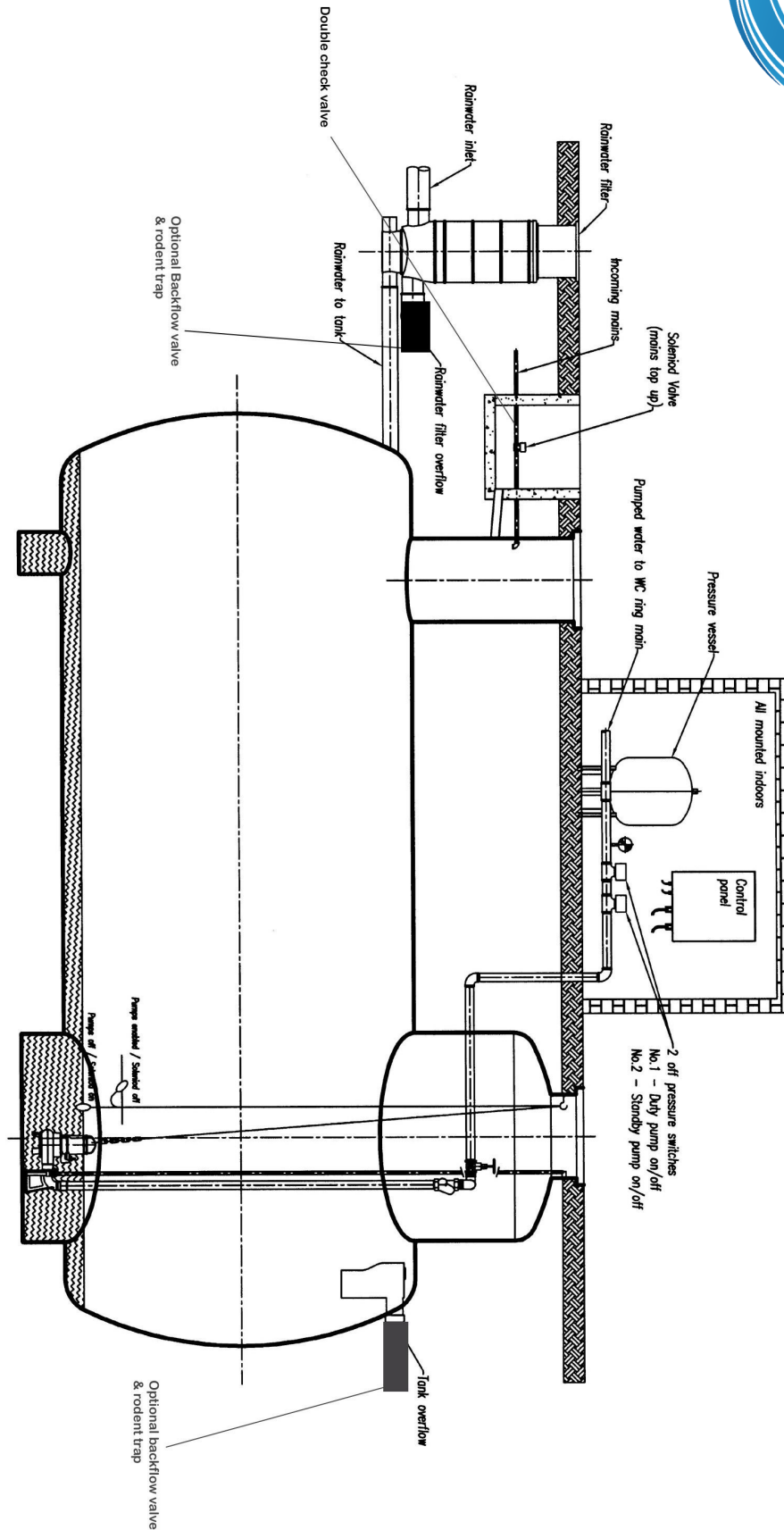

Registered Office:

New Haden Pumps Ltd,
 Draycott Cross Road, Cheadle, Staffs, ST10 2NW
 Registered in England, No. 826997
 VAT No. 849 7500 90

Tel: 01538 757900
 Fax: 01538 757999
 E-mail: info@NHPumps.com



Southern Office:

New Haden Pumps Ltd,
 Unit 57, Waterhouse Business Centre,
 2, Cromar Way, Chelmsford, Essex,
 CM1 2QE

Tel: 01245 392147
 E-mail: southern@nhpumps.com

New Haden Pumps

Rainwater Harvesting

enviro-PAC Storage Tank

(below ground domestic range)

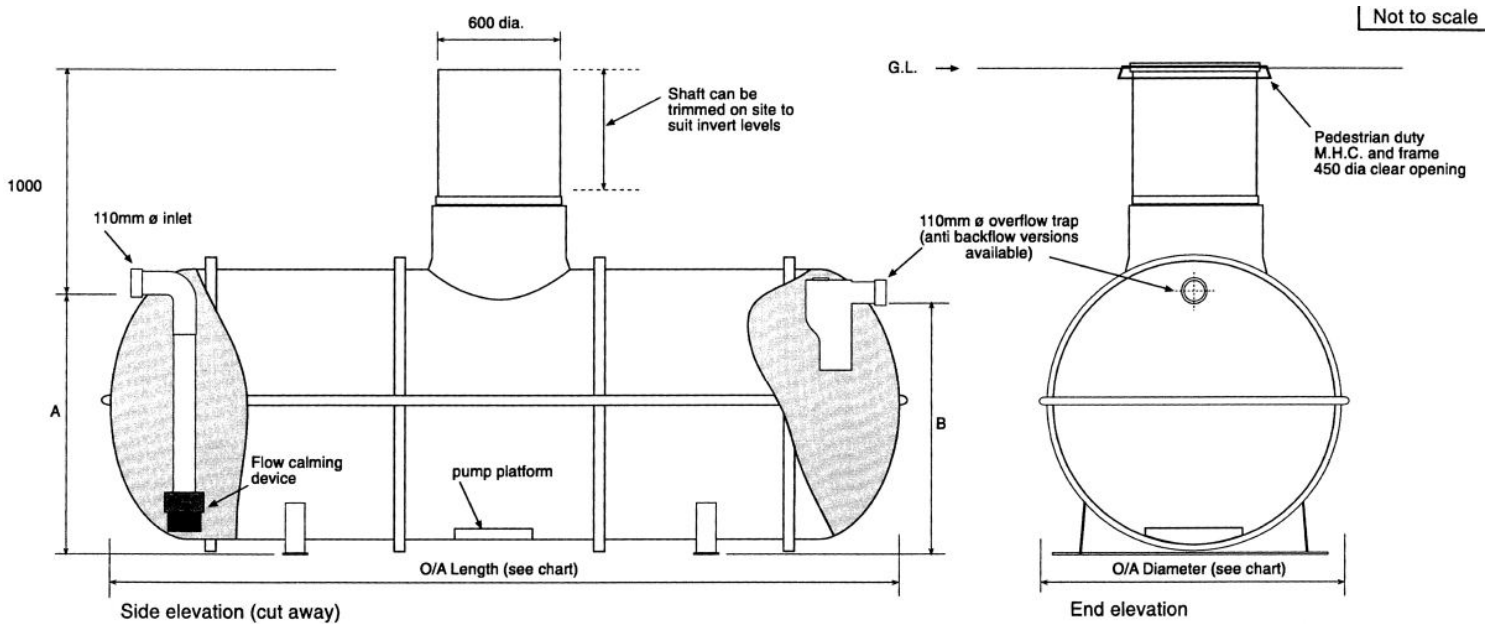

NB. This range is designed for domestic applications; larger capacities and designs are available on request.

Capacity litres (nominal)	Diameter (mm)	O/A Length (mm)	A (mm)	B (mm)
1200	1000	1780	1050	850
1500	1200	1660	1250	1050
2000	1200	220	1250	1050
2400	1200	2470	1250	1050
3000	1500	2150	1500	1300
4000	1500	2700	1500	1300
5000	1500	3250	1500	1300
6000	1850	2850	1820	1620
7500	1850	3600	1820	1620
10000	1850	4450	1820	1620
12000	1850	5400	1820	1620

other sizes can be manufactured to suit requirements

Registered Office:

New Haden Pumps Ltd,
 Draycott Cross Road, Cheadle, Staffs, ST10 2NW
 Registered in England, No. 826997
 VAT No. 849 7500 90

Tel: 01538 757900
 Fax: 01538 757999
 E-mail: info@NHPumps.com

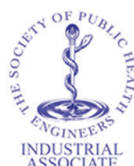

Southern Office:

New Haden Pumps Ltd,
 Unit 57, Waterhouse Business Centre,
 2, Cromar Way, Chelmsford, Essex,
 CM1 2QE

Tel: 01245 392147
 E-mail: southern@nhpumps.com